

# BLF4G10-120; BLF4G10S-120

UHF power LDMOS transistor

Rev. 01 — 10 January 2006

Product data sheet

## 1. Product profile

### 1.1 General description

120 W LDMOS power transistor for base station applications at frequencies from 800 MHz to 1000 MHz.

**Table 1: Typical performance**

*RF performance at  $T_h = 25^\circ\text{C}$  in a common base class-AB test circuit.*

Mode of operation	f (MHz)	V <sub>DS</sub> (V)	P <sub>L</sub> (W)	G <sub>p</sub> (dB) (typ)	$\eta_D$ (%)	ACPR <sub>400</sub> (dBc) (typ)	ACPR <sub>600</sub> (dBc) (typ)	EVM <sub>rms</sub> (%)	IMD3 (dBc) (typ)
CW	861 to 961	28	120	19	57	-	-	-	-
GSM EDGE	861 to 961	28	48 (AV)	19	40	-61 [1]	-72 [2]	1.5	-
2-tone	861 to 961	28	120 (PEP)	19	46	-	-	-	-31

[1] ACPR<sub>400</sub> at 30 kHz resolution bandwidth

[2] ACPR<sub>600</sub> at 30 kHz resolution bandwidth

### CAUTION



This device is sensitive to ElectroStatic Discharge (ESD). Therefore care should be taken during transport and handling.

### 1.2 Features

- Typical GSM EDGE performance at frequency of 960 MHz, a supply voltage of 28 V and an I<sub>DQ</sub> of 850 mA:
  - ◆ Load power = 48 W (AV)
  - ◆ Gain = 19 dB (typ)
  - ◆ Efficiency = 40 % (typ)
  - ◆ ACPR<sub>400</sub> = -61 dBc (typ)
  - ◆ ACPR<sub>600</sub> = -72 dBc (typ)
  - ◆ EVM<sub>rms</sub> = 1.5 % (typ)
- Easy power control
- Excellent ruggedness
- High efficiency
- Excellent thermal stability
- Designed for broadband operation (800 MHz to 1000 MHz)
- Internally matched for ease of use

**PHILIPS**

## 1.3 Applications

- RF power amplifiers for GSM, GSM EDGE and CDMA base stations and multicarrier applications in the 800 MHz to 1000 MHz frequency range.

## 2. Pinning information

Table 2: Pinning

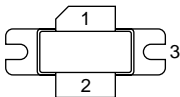
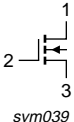
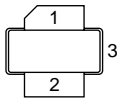
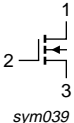
Pin	Description	Simplified outline	Symbol
<b>BLF4G10-120 (SOT502A)</b>			
1	drain		 sym039
2	gate		
3	source		
<b>BLF4G10S-120 (SOT502B)</b>			
1	drain		 sym039
2	gate		
3	source		

[1] Connected to flange

## 3. Ordering information

Table 3: Ordering information

Type number	Package		
	Name	Description	Version
BLF4G10-120	-	flanged LDMOST ceramic package; 2 mounting holes; 2 leads	SOT502A
BLF4G10S-120	-	earless flanged LDMOST ceramic package; 2 leads	SOT502B

## 4. Limiting values

Table 4: Limiting values

In accordance with the Absolute Maximum Rating System (IEC 60134).

Symbol	Parameter	Conditions	Min	Max	Unit
$V_{DS}$	drain-source voltage		-	65	V
$V_{GS}$	gate-source voltage		-0.5	+15	V
$I_D$	drain current		-	12	A
$T_{stg}$	storage temperature		-65	+150	°C
$T_j$	junction temperature		-	200	°C

## 5. Thermal characteristics

**Table 5: Thermal characteristics**

Symbol	Parameter	Conditions	Min	Typ	Max	Unit
$R_{th(j-case)}$	thermal resistance from junction to case	$T_{case} = 80\text{ °C}$				
		$P_L = 60\text{ W}$	-	0.76	0.85	K/W
		$P_L = 120\text{ W}$	-	0.65	0.74	K/W

## 6. Characteristics

**Table 6: Characteristics**

$T_j = 25\text{ °C}$ ; unless otherwise specified.

Symbol	Parameter	Conditions	Min	Typ	Max	Unit
$V_{(BR)DSS}$	drain-source breakdown voltage	$V_{GS} = 0\text{ V}$ ; $I_D = 0.9\text{ mA}$	65	-	-	V
$V_{GS(th)}$	gate-source threshold voltage	$V_{DS} = 10\text{ V}$ ; $I_D = 180\text{ mA}$	2.5	3.1	3.5	V
$V_{GSq}$	gate-source quiescent voltage	$V_{DS} = 28\text{ V}$ ; $I_D = 900\text{ mA}$	2.7	3.2	3.7	V
$I_{DSS}$	drain leakage current	$V_{GS} = 0\text{ V}$ ; $V_{DS} = 28\text{ V}$	-	-	3	$\mu\text{A}$
$I_{DSX}$	drain cut-off current	$V_{GS} = V_{GS(th)} + 6\text{ V}$ ; $V_{DS} = 10\text{ V}$	27	30	-	A
$I_{GSS}$	gate leakage current	$V_{GS} = 15\text{ V}$ ; $V_{DS} = 0\text{ V}$	-	-	300	nA
$g_{fs}$	forward transconductance	$V_{DS} = 10\text{ V}$ ; $I_D = 10\text{ A}$	-	9.0	-	S
$R_{DS(on)}$	drain-source on-state resistance	$V_{GS} = V_{GS(th)} + 6\text{ V}$ ; $I_D = 6\text{ A}$	-	0.09	-	$\Omega$
$C_{rs}$	feedback capacitance	$V_{GS} = 0\text{ V}$ ; $V_{DS} = 28\text{ V}$ ; $f = 1\text{ MHz}$	-	2.5	-	pF

## 7. Application information

**Table 7: Application information**

Mode of operation: 2-tone (100 kHz tone spacing);  $f = 960\text{ MHz}$ .

$V_{DS} = 28\text{ V}$ ;  $I_{Dq} = 850\text{ mA}$ ;  $T_{case} = 25\text{ °C}$ ; unless otherwise specified.

Symbol	Parameter	Conditions	Min	Typ	Max	Unit
$G_p$	power gain	$P_{L(PEP)} = 120\text{ W}$	18	19	-	dB
IRL	input return loss	$P_{L(PEP)} = 120\text{ W}$	-	-8	-5	dB
$\eta_D$	drain efficiency	$P_{L(PEP)} = 120\text{ W}$	44	46	-	%
IMD3	third order intermodulation distortion	$P_{L(PEP)} = 120\text{ W}$	-	-31	-27	dBc

### 7.1 Ruggedness in class-AB operation

The BLF4G10-120 and BLF4G10S-120 are capable of withstanding a load mismatch corresponding to  $V_{SWR} = 10 : 1$  through all phases under the following conditions:  $V_{DS} = 28\text{ V}$ ;  $I_{Dq} = 850\text{ mA}$ ;  $P_L = 120\text{ W (CW)}$ ;  $f = 960\text{ MHz}$ .

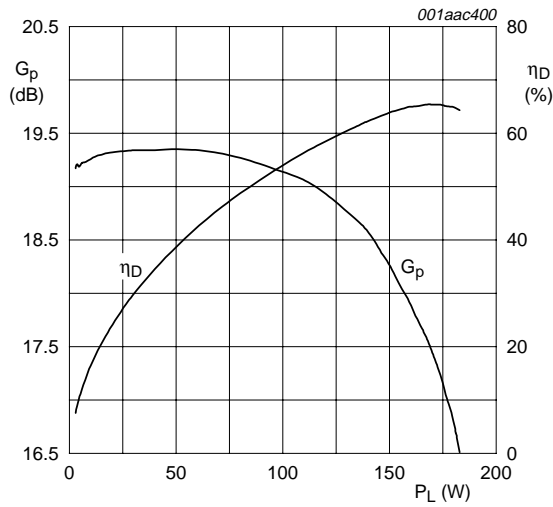

$V_{DS} = 28\text{ V}$ ;  $I_{Dq} = 850\text{ mA}$ ;  $T_{case} = 25\text{ }^\circ\text{C}$ ;  
 $f = 960\text{ MHz}$

**Fig 1. One-tone CW power gain and drain efficiency as functions of load power; typical values**

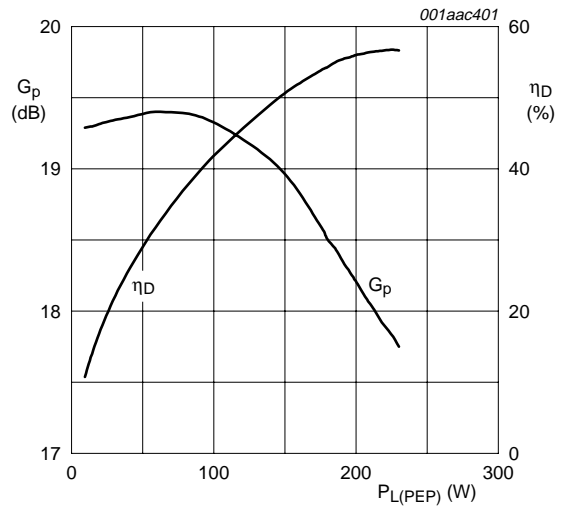

$V_{DS} = 28\text{ V}$ ;  $I_{Dq} = 850\text{ mA}$ ;  $T_{case} = 25\text{ }^\circ\text{C}$ ;  
 $f = 960\text{ MHz}$

**Fig 2. Two-tone CW power gain and drain efficiency as functions of peak envelope load power; typical values**

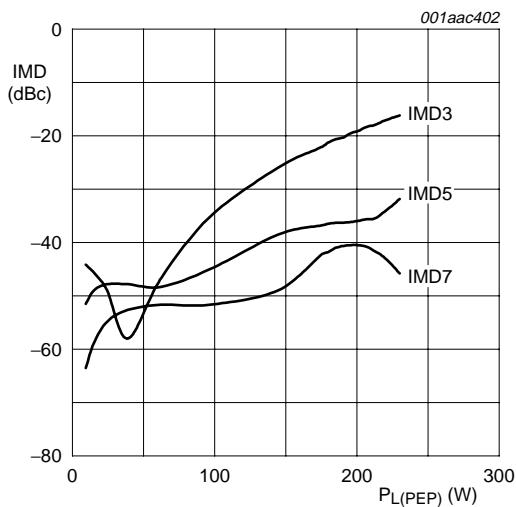

$V_{DS} = 28\text{ V}$ ;  $I_{Dq} = 850\text{ mA}$ ;  $T_{case} = 25\text{ }^\circ\text{C}$ ;  
 $f = 960\text{ MHz}$

**Fig 3. Intermodulation distortion as a function of peak envelope load power; typical values**

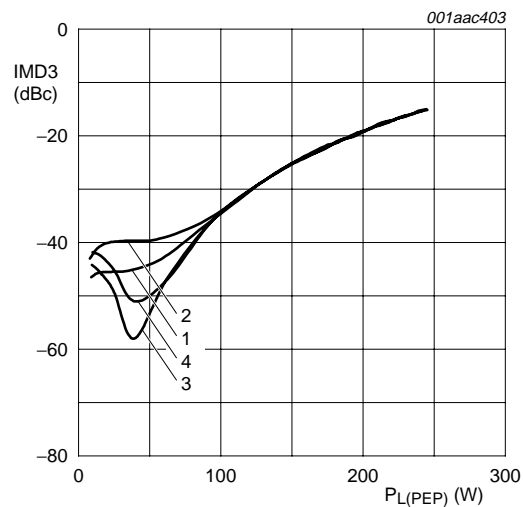

$V_{DS} = 28\text{ V}$ ;  $T_{case} = 25\text{ }^\circ\text{C}$ ;  $f = 960\text{ MHz}$

- (1)  $I_{Dq} = 650\text{ mA}$
- (2)  $I_{Dq} = 750\text{ mA}$
- (3)  $I_{Dq} = 850\text{ mA}$
- (4)  $I_{Dq} = 950\text{ mA}$

**Fig 4. Third order intermodulation distortion as a function of peak envelope load power; typical values**

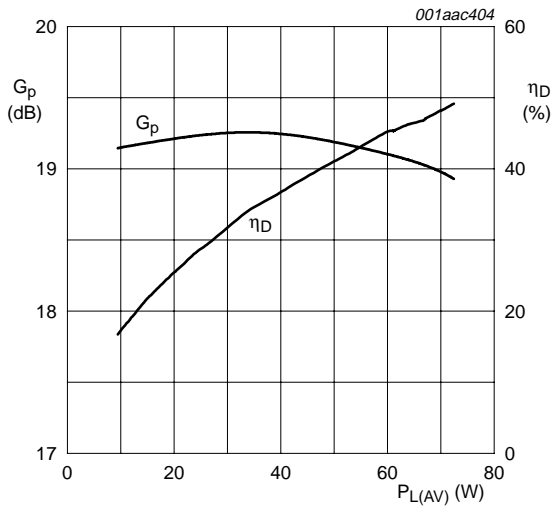

$V_{DS} = 28\text{ V}$ ;  $I_{Dq} = 850\text{ mA}$ ;  $T_{case} = 25\text{ }^\circ\text{C}$ ;  
 $f = 960\text{ MHz}$

**Fig 5. GSM EDGE power gain and drain efficiency as functions of average load power; typical values**

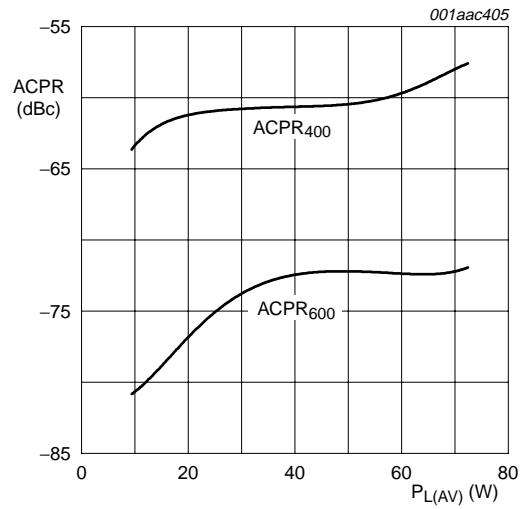

$V_{DS} = 28\text{ V}$ ;  $I_{Dq} = 850\text{ mA}$ ;  $T_{case} = 25\text{ }^\circ\text{C}$ ;  
 $f = 960\text{ MHz}$

**Fig 6. GSM EDGE ACPR at 400 kHz and at 600 kHz as functions of average load power; typical values**

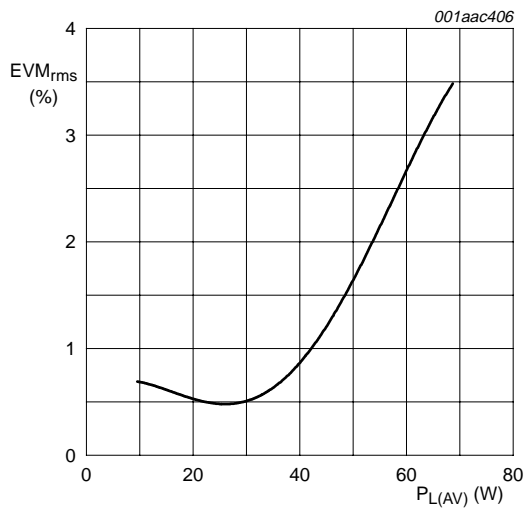

$V_{DS} = 28\text{ V}$ ;  $I_{Dq} = 850\text{ mA}$ ;  $T_{case} = 25\text{ }^\circ\text{C}$ ;  
 $f = 960\text{ MHz}$

**Fig 7. GSM EDGE rms EVM as a function of average load power; typical values**

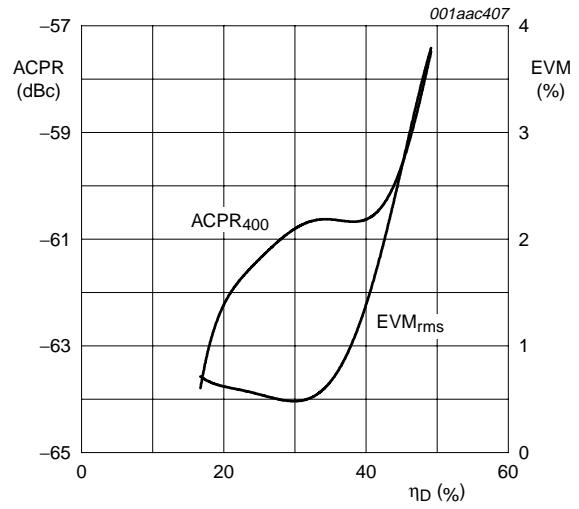

$V_{DS} = 28\text{ V}$ ;  $I_{Dq} = 850\text{ mA}$ ;  $T_{case} = 25\text{ }^\circ\text{C}$ ;  
 $f = 960\text{ MHz}$

**Fig 8. GSM EDGE ACPR at 400 kHz and rms EVM as functions of drain efficiency; typical values**

8. Test information

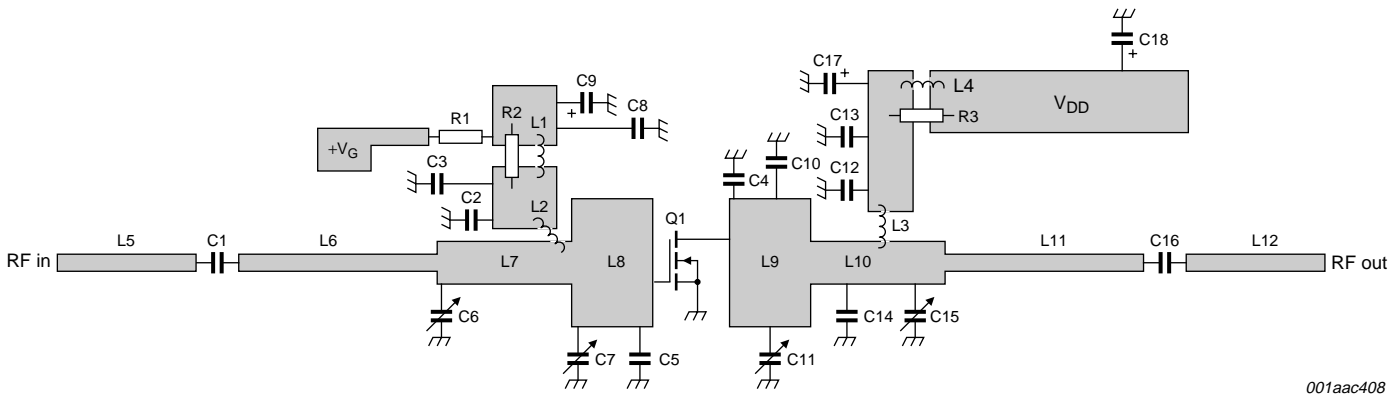

See [Table 8](#) for list of components.

Fig 9. Class-AB test circuit for operation at 960 MHz

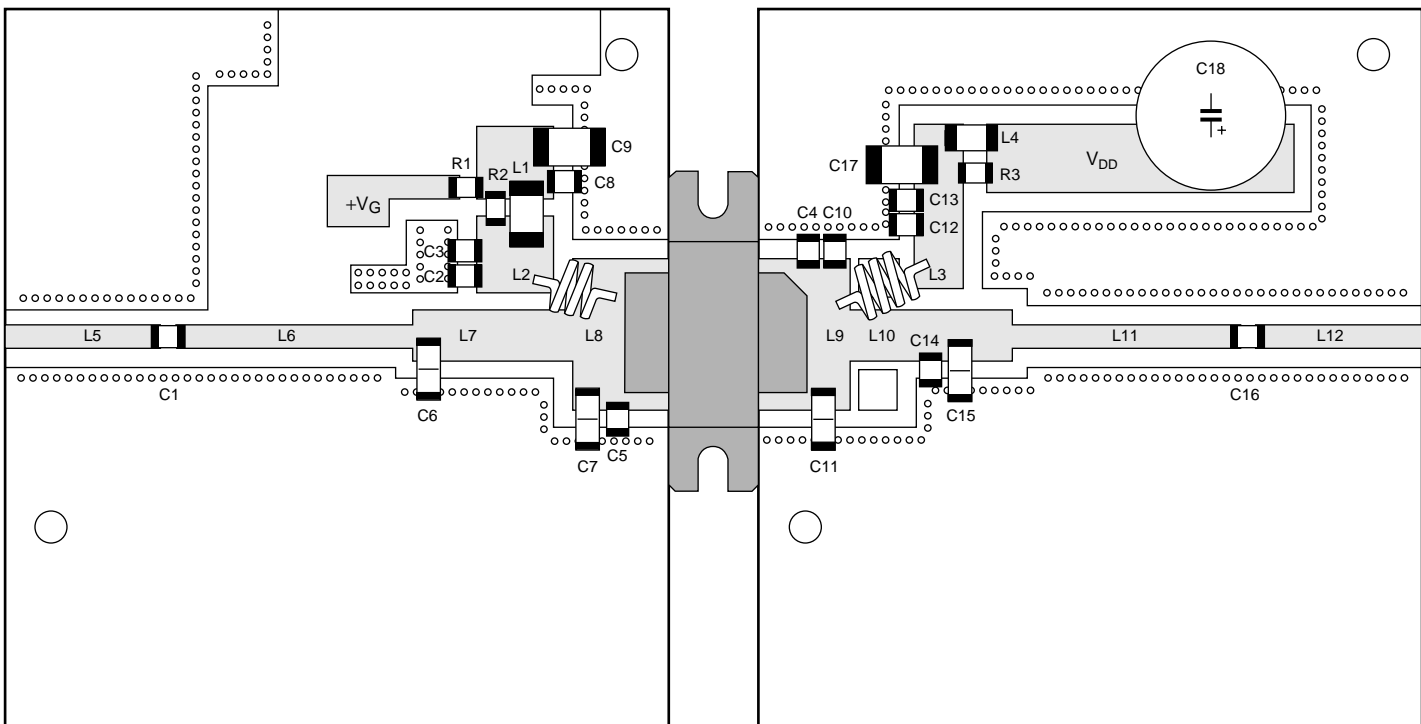

001aac409

The components are situated on one side of the copper-clad Printed-Circuit Board (PCB) with Duroid dielectric ( $\epsilon_r = 2.5$ ), thickness 31 mils.

The other side is unetched and serves as a ground plane.

See [Table 8](#) for list of components.

**Fig 10. Component layout for 960 MHz test circuit**

Table 8: List of components (see Figure 9 and Figure 10)

Component	Description	Value	Dimensions
C1	multilayer ceramic chip capacitor	[1] 30 pF	
C2, C12	multilayer ceramic chip capacitor	[1] 47 pF	
C3, C13	multilayer ceramic chip capacitor	[1] 300 pF	
C4	multilayer ceramic chip capacitor	[1] 6.2 pF	
C5	multilayer ceramic chip capacitor	[1] 7.5 pF	
C6, C7, C11, C15	trimmer capacitors (Tekelec)	[2] 0.8 pF to 8 pF	
C8	multilayer ceramic chip capacitor	20 nF	
C9	tantalum capacitor	10 $\mu$ F; 35 V	
C10	multilayer ceramic chip capacitor	[1] 6.8 pF	
C14	multilayer ceramic chip capacitor	[1] 5.1 pF	
C16	multilayer ceramic chip capacitor	[1] 56 pF	
C17	tantalum capacitor	[3] 10 $\mu$ F; 35 V	
C18	electrolytic capacitor	220 $\mu$ F; 63 V	
L1	ferrite bead (long)	grade 4S2	
L2	3 turn inductor ID 4.5 mm, Cu-wire diameter 1 mm		
L3	4 turn inductor ID 3 mm, Cu-wire diameter 1 mm		
L4	ferrite bead (short)	grade 4S2	
L5	stripline	[4] $Z_0 = 50 \Omega$	(W $\times$ L) 2 mm $\times$ 17.2 mm
L6	stripline	[4] $Z_0 = 50 \Omega$	(W $\times$ L) 2 mm $\times$ 25.4 mm
L7	stripline	[4] $Z_0 = 25 \Omega$	(W $\times$ L) 5.6 mm $\times$ 17.4 mm
L8	stripline	[4] $Z_0 = 10 \Omega$	(W $\times$ L) 16 mm $\times$ 10.2 mm
L9	stripline	[4] $Z_0 = 10 \Omega$	(W $\times$ L) 16 mm $\times$ 10.2 mm
L10	stripline	[4] $Z_0 = 25 \Omega$	(W $\times$ L) 5.6 mm $\times$ 17.4 mm
L11	stripline	[4] $Z_0 = 50 \Omega$	(W $\times$ L) 2 mm $\times$ 25.4 mm
L12	stripline	[4] $Z_0 = 50 \Omega$	(W $\times$ L) 2 mm $\times$ 17.2 mm
R1	SMD resistor	8.2 $\Omega$ ; 0.1 W	
R2	SMD resistor	4.7 $\Omega$ ; 0.1 W	
R3	metal film resistor	10 $\Omega$ ; 0.6 W	

[1] American Technical Ceramics type 100B or capacitor of same quality.

[2] Mounted flat.

[3] Low ESR.

[4] Striplines are on a double copper-clad Ultralam 2000 PCB ( $\epsilon_r = 2.5$ ); thickness = 31 mils.



**9. Package outline**

Flanged LDMOST ceramic package; 2 mounting holes; 2 leads

SOT502A

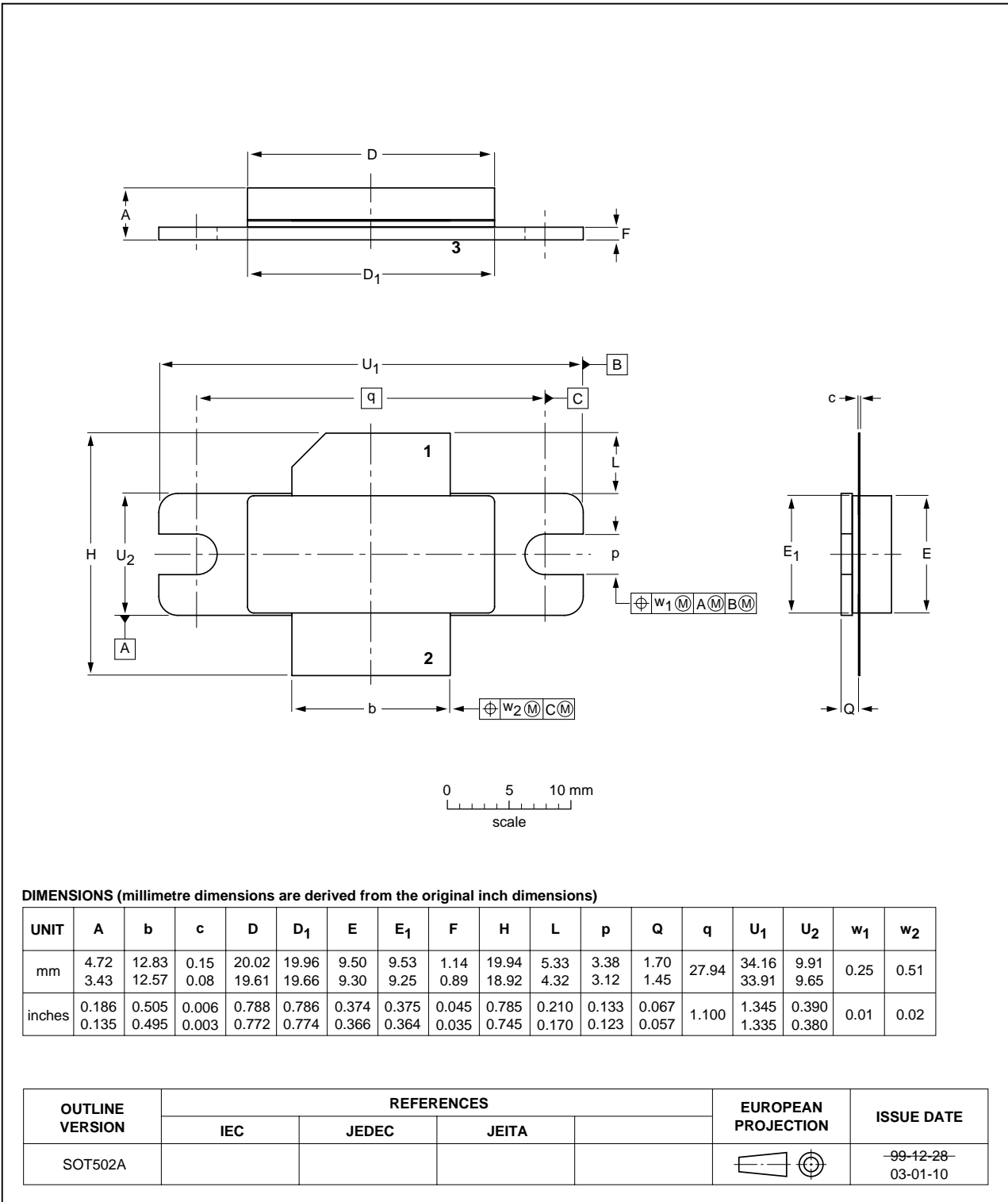

Fig 11. Package outline SOT502A

Earless flanged LDMOST ceramic package; 2 leads

SOT502B

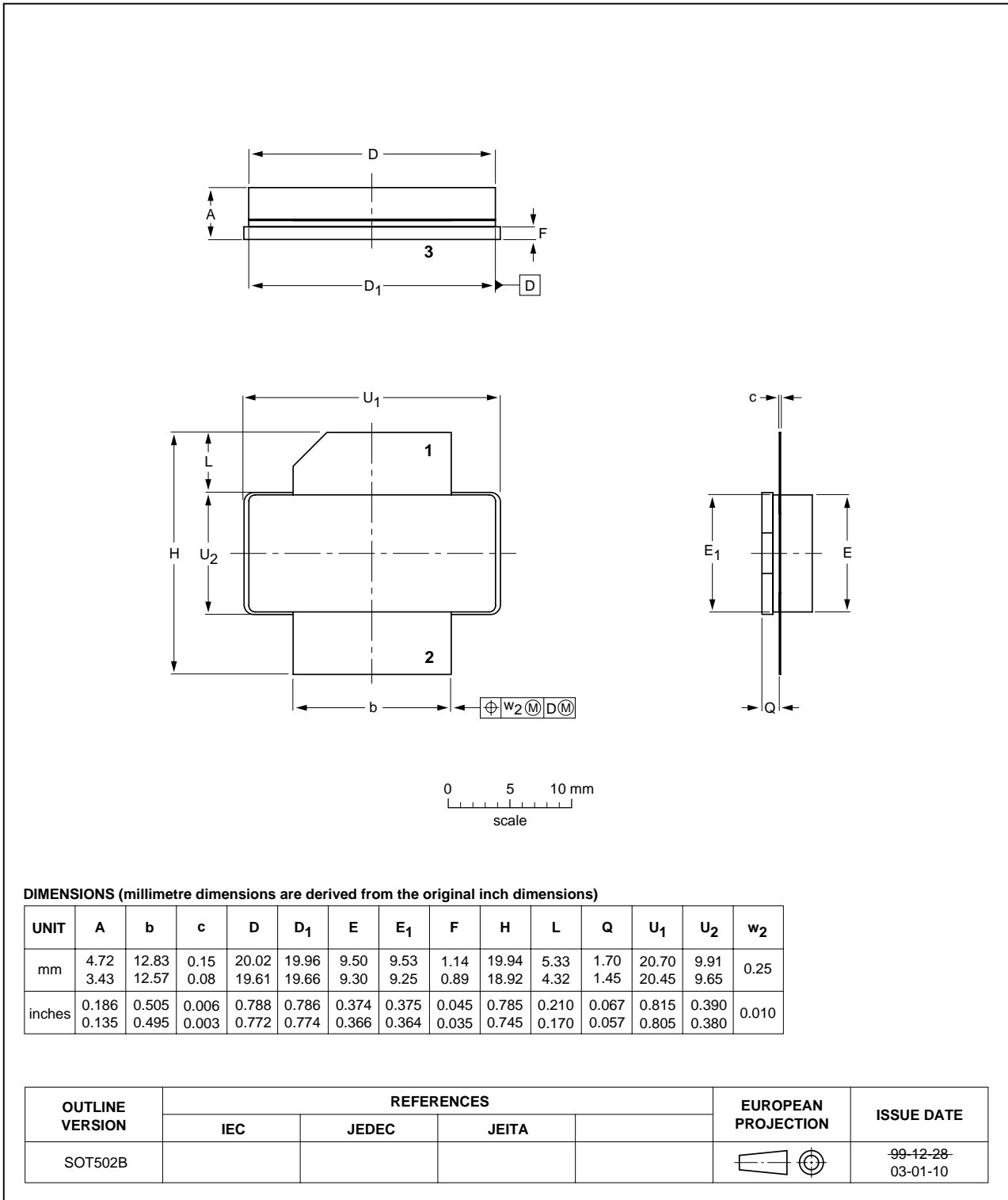

Fig 12. Package outline SOT502B

## 10. Abbreviations

**Table 9: Abbreviations**

Acronym	Description
ACPR	Adjacent Channel Power Ratio
CDMA	Code Division Multiple Access
CW	Continuous Wave
EDGE	Enhanced Data rates for GSM Evolution
ESR	Equivalent Series Resistance
EVM	Error Vector Magnitude
GSM	Global System for Mobile communications
$I_{Dq}$	quiescent drain current
LDMOS	Laterally Diffused Metal Oxide Semiconductor
PEP	Peak Envelope Power
RF	Radio Frequency
SMD	Surface-Mount Device
VSWR	Voltage Standing-Wave Ratio

## 11. Revision history

---

**Table 10: Revision history**

Document ID	Release date	Data sheet status	Change notice	Doc. number	Supersedes
BLF4G10-120_ 4G10S-120_1	20060110	Product data sheet	-	9397 750 14549	-

---

## 12. Data sheet status

Level	Data sheet status <sup>[1]</sup>	Product status <sup>[2] [3]</sup>	Definition
I	Objective data	Development	This data sheet contains data from the objective specification for product development. Philips Semiconductors reserves the right to change the specification in any manner without notice.
II	Preliminary data	Qualification	This data sheet contains data from the preliminary specification. Supplementary data will be published at a later date. Philips Semiconductors reserves the right to change the specification without notice, in order to improve the design and supply the best possible product.
III	Product data	Production	This data sheet contains data from the product specification. Philips Semiconductors reserves the right to make changes at any time in order to improve the design, manufacturing and supply. Relevant changes will be communicated via a Customer Product/Process Change Notification (CPCN).

[1] Please consult the most recently issued data sheet before initiating or completing a design.

[2] The product status of the device(s) described in this data sheet may have changed since this data sheet was published. The latest information is available on the Internet at URL <http://www.semiconductors.philips.com>.

[3] For data sheets describing multiple type numbers, the highest-level product status determines the data sheet status.

## 13. Definitions

**Short-form specification** — The data in a short-form specification is extracted from a full data sheet with the same type number and title. For detailed information see the relevant data sheet or data handbook.

**Limiting values definition** — Limiting values given are in accordance with the Absolute Maximum Rating System (IEC 60134). Stress above one or more of the limiting values may cause permanent damage to the device. These are stress ratings only and operation of the device at these or at any other conditions above those given in the Characteristics sections of the specification is not implied. Exposure to limiting values for extended periods may affect device reliability.

**Application information** — Applications that are described herein for any of these products are for illustrative purposes only. Philips Semiconductors makes no representation or warranty that such applications will be suitable for the specified use without further testing or modification.

## 14. Disclaimers

**Life support** — These products are not designed for use in life support appliances, devices, or systems where malfunction of these products can reasonably be expected to result in personal injury. Philips Semiconductors

## 16. Contact information

For additional information, please visit: <http://www.semiconductors.philips.com>

For sales office addresses, send an email to: [sales.addresses@www.semiconductors.philips.com](mailto:sales.addresses@www.semiconductors.philips.com)

customers using or selling these products for use in such applications do so at their own risk and agree to fully indemnify Philips Semiconductors for any damages resulting from such application.

**Right to make changes** — Philips Semiconductors reserves the right to make changes in the products - including circuits, standard cells, and/or software - described or contained herein in order to improve design and/or performance. When the product is in full production (status 'Production'), relevant changes will be communicated via a Customer Product/Process Change Notification (CPCN). Philips Semiconductors assumes no responsibility or liability for the use of any of these products, conveys no license or title under any patent, copyright, or mask work right to these products, and makes no representations or warranties that these products are free from patent, copyright, or mask work right infringement, unless otherwise specified.

## 15. Trademarks

**Notice** — All referenced brands, product names, service names and trademarks are the property of their respective owners.

## 17. Contents

---

<b>1</b>	<b>Product profile</b> .....	<b>1</b>
1.1	General description .....	1
1.2	Features .....	1
1.3	Applications .....	2
<b>2</b>	<b>Pinning information</b> .....	<b>2</b>
<b>3</b>	<b>Ordering information</b> .....	<b>2</b>
<b>4</b>	<b>Limiting values</b> .....	<b>2</b>
<b>5</b>	<b>Thermal characteristics</b> .....	<b>3</b>
<b>6</b>	<b>Characteristics</b> .....	<b>3</b>
<b>7</b>	<b>Application information</b> .....	<b>3</b>
7.1	Ruggedness in class-AB operation .....	3
<b>8</b>	<b>Test information</b> .....	<b>6</b>
<b>9</b>	<b>Package outline</b> .....	<b>9</b>
<b>10</b>	<b>Abbreviations</b> .....	<b>11</b>
<b>11</b>	<b>Revision history</b> .....	<b>12</b>
<b>12</b>	<b>Data sheet status</b> .....	<b>13</b>
<b>13</b>	<b>Definitions</b> .....	<b>13</b>
<b>14</b>	<b>Disclaimers</b> .....	<b>13</b>
<b>15</b>	<b>Trademarks</b> .....	<b>13</b>
<b>16</b>	<b>Contact information</b> .....	<b>13</b>



© Koninklijke Philips Electronics N.V. 2006

All rights are reserved. Reproduction in whole or in part is prohibited without the prior written consent of the copyright owner. The information presented in this document does not form part of any quotation or contract, is believed to be accurate and reliable and may be changed without notice. No liability will be accepted by the publisher for any consequence of its use. Publication thereof does not convey nor imply any license under patent- or other industrial or intellectual property rights.

Date of release: 10 January 2006  
Document number: 9397 750 14549

Published in The Netherlands